

## **Practical Solutions to Common Ship Motion Problems**

Barry Deakin & Peter Weynberg, Wolfson Unit M.T.I.A.

Ship motions have an important influence on passenger comfort and crew performance, and often limit the speed of a vessel in certain conditions because of these or structural considerations. It is surprising that many owners and crews are resigned to the poor performance of their yachts in the, frequently mistaken, belief that nothing can be done to improve the situation.

Size and displacement are fundamental parameters which dominate ship motions, and buying a larger yacht will normally guarantee more comfort for the owner, but some aspects of seakeeping may benefit from modest alterations to the yacht or the way in which it is operated.

### **Bilge Keels to Reduce Roll Motions**

It is commonly supposed that if active fin stabilisers are fitted, bilge keels are unnecessary. Fin stabilisers are only of benefit when the yacht is under way at a reasonable cruising speed, because they depend on generating substantial forces to counteract the roll by being inclined at an angle to the flow past the hull. When operating at low speed or, most importantly for a motor yacht, when at anchor, the fin stabilisers have a minimal effect on the rolling motion.

Ship rolling is characterised by a high dependence on frequency, with large amplitudes around the resonant frequency. As such it responds best to the application of damping, which will reduce the amplitude around the resonant, or natural, frequency and at higher frequencies. When the yacht is not under way bilge keels provide a damping effect on the rolling as a result of their interference with the apparent flow around the hull girth. When under way this damping effect increases dramatically with speed.

Figure 1 presents model test data for a typical motor yacht of round bilge form, where the roll response represents the roll angle for a constant wave slope, for a range of wave periods. It illustrates the dependence of roll response on frequency, or on period as it is presented here. The yacht was fitted with large fin stabilisers but no bilge keels, and was renowned for being uncomfortable at anchor. Two sizes of keels were tested and the yacht was fitted with the larger, 500 mm deep, bilge keels. The test data suggested that they would reduce the roll response by 40% at the yacht's natural roll period of 5 seconds, and in practice the owner was delighted at the transformation.

Close inspection of Figure 1 reveals that the addition of bilge keels shifts the resonant frequency slightly, giving the yacht a longer natural roll period. This is because the presence of the keels causes an increase in the added inertia in roll by increasing the amount of water entrained around the hull as it rolls. The roll response remains virtually unaffected at the longer roll periods, and this demonstrates a limitation of bilge keels, that they will not reduce the roll amplitude in response to long ocean swells.

Figure 2 presents the output from a roll gyro installed in a model of a 60 metre motor yacht to measure the affect of the proposed 700 mm deep bilge keels on the roll decay. This roll decrement test involved rolling the model manually in calm water and monitoring the subsequent rolls to port and starboard. It can be seen that, with the keels fitted, the roll decays much more rapidly at first, when the roll angle is large. Within four cycles the roll angle with the keels fitted is less than 60% of that without the keels.

The benefit of the keels is maximised when the yacht is experiencing the most onerous conditions of a high seastate with a wave encounter period close to the natural roll period. Figure 3 presents data for the same 60 metre yacht in a range of seastates. In low seastates the keels have little effect because the roll angles are very small. In the higher seastates, with mean wave periods close to the natural roll period of the yacht, the benefit of large keels is substantial.

A surprising number of motor yachts of round bilge form are built with no bilge keels, and if they are fitted they are likely to be small, perhaps in order to facilitate construction or minimise their resistance penalty. The keels typically are constructed of a standard bulb edged steel section, 150 or 200 mm deep. These are welded to the hull, along a diagonal, at the turn of bilge. They may occupy the mid third of the hull's length, but if fin stabilisers are fitted near midships the bilge keels may be considerably shorter.

Their damping effect is roughly proportional to the area of the keels but their length is limited at the bow by the desirability of keeping them immersed when the ship pitches in head seas, and at the stern by the need to avoid disturbance of the flow to the propellers. There should be a great incentive therefore to maximise the depth of the keels, within the existing limitations of draught and waterline beam, but there seems to be some reluctance on the part of designers and builders to commit themselves to deep bilge keels.

The fear that large keels may bring a heavy resistance penalty is unfounded, provided that they are properly aligned to the flow along the hull. Without performing towing tank tests it is not possible to predict the correct alignment, and so most bilge keels which are fitted along a diagonal do impose a resistance penalty. Figure 4 shows an example of a coastal survey vessel which was renowned for its poor roll characteristics despite having bilge keels fitted. This photograph of a paint flow visualisation test, which was conducted with the original keels fitted, illustrates the poor alignment of those keels. Figure 5 shows the flow visualisation test in the absence of the keels, from which the flow streamlines were derived, and the new keel alignment determined.

Figure 6 illustrates graphically the result of these tests, and the differences in keel alignment are clear. Figure 7 presents the resistance data for the two keel configurations, with data for the bare hull as a comparison. The original keels were 400 mm deep flat plates, and the new keels were triangular in cross section, 1 metre deep by 730 mm wide at the hull. Despite this large increase in cross section, and a 60% increase in length, they resulted in no additional resistance at the ship's service speed. The ship motions were transformed after fitting the larger keels, and no speed penalty was suffered.

Although correct alignment requires towing tank tests, these can be conducted on a relatively small model and only a brief program of tests is necessary. Figure 8 shows a 2.4 metre long towing tank model of a large motor yacht with bilge keels and fin stabilisers fitted.

Large keels are best constructed with a triangular cross section in order to spread the loads, which will may be of the order of a tonne per metre length, on to the hull structure. They are simple to construct however, can be retro-fitted with only a brief spell in dry dock, do not affect the internal arrangement or the appearance of the yacht, incur no running or maintenance costs, and will bring dramatic benefits throughout the life of the yacht.

### **Spray Rails and Knuckles to Reduce Wetness**

Vessels which are perfectly acceptable when going slowly, or in low sea and light wind conditions, frequently become extremely wet on deck, with limited visibility from the wheelhouse due to spray, as the seastate or their speed increases. The performance of these vessels may have been satisfactory

during trials or towing tank tests, but seastate, and perhaps displacement, differences can have significant effects on wetness. This characteristic of the seakeeping may never have been good, but was perhaps accepted as being an inevitable result of the selected hull shape.

Problems with wetness and visibility often can be reduced or eliminated with the introduction or increase in size of bow spray rails and knuckles. When deciding whether any deficiency can be overcome, it is not easy, nor economic, to try it on the full size vessel, particularly if it is the incorporation or increase of a bow knuckle. Invariably the modification will be cheaper, and have a greater certainty of success, if it is tested first at model scale in the controlled conditions of a towing tank.

The sequences of photographs in Figures 9 and 10 show a model under test both with and without spray rails forward. This motor yacht was very wet in even a modest sea state of only 1 metre significant height, where green water and spray was above the bulwarks, but with a spray rail fitted it was completely dry. The spray rail as fitted was just 100mm wide full scale, and the wetness was sensitive to its vertical location. The tests enabled the rail to be fitted in the confidence that its location would give good performance in the expected sea conditions, while maintaining the attractive styling of the yacht.

The choice between spray rail and knuckle is dependent on a number of factors, with both the existing hull shape and the styling being very important. A knuckle will be more expensive, and probably add more weight, than a rail, but if an ineffective knuckle is incorporated already then generally it will be better to enlarge it. If a very large rail is required to overcome deficiencies then it may always look like an afterthought, and it may be better to incorporate a knuckle which tends to look more seamanlike.

#### **Use of an Acceleration Meter to Improve Seakindliness**

The seakindliness of a vessel can be taken to mean many things. In this paper primarily it is the motion of the vessel and its impact upon the owner, guests and their well being. The way in which a vessel is operated will affect the seakindliness, and it has been assumed that the vessels are operated with due regard to the observance of good seamanship.

From experience it has been found that there are several measures that may be used to assess the seakindliness quality of a vessel. These parameters are:

1. Deck Acceleration, which is a combination of transverse acceleration and the acceleration due to roll angle. This gives a measure of whether objects will stay on a horizontal surface and the ease with which one may walk along a fore and aft alleyway.
2. Vertical Acceleration, which is the local heave acceleration. This gives a measure of the degree of weightlessness felt and the ease with which one may write or eat.
3. Subjective Motion Parameter, which is a frequency weighted vertical acceleration. This gives a measure of the ability of the crew to work efficiently and, for people adapted to life at sea, their feeling of well being.
4. Incidence of Seasickness, which is also a frequency weighted vertical acceleration. This gives a measure of the likelihood of people not used to the sea being seasick within a given voyage duration.

The first three parameters are readily noticed by the people on board as soon as the vessel encounters waves. The fourth parameter, the onset of seasickness, is not noticed immediately since it takes time for people to reach their dose threshold. For some people unadapted to life at sea, primarily the

guests and possibly the owner, this threshold is reached relatively soon, maybe in less than an hour depending on sea state. When an owner and guests are on board it is up to the captain to ensure that they are comfortable. What might start out as an interesting and sometimes thrilling trip, soon deteriorates into abject misery as the guests succumb to the rigours of the sea. It is too late to look for a solution once people are sick, except to get them ashore or in a sheltered anchorage. Action must be taken as soon as the threat of seasickness is likely.

From the captain's point of view, how does he determine the seasickness risk, what does he do about it and how does he know his solution is effective, all before the guests are feeling unwell?

The British Standard Incidence of Seasickness (BSI%) provides a means of predicting the percentage of passengers likely to be seasick in a given environment. It is derived using the method described in British Standard BS6841:1987 and is based upon measurements and data from mixed groups of passengers on ferries. The value is based on the filtered and weighted vertical acceleration integrated with time to give a dose value. The percentage of guests who may vomit during the time period is some constant times a dose value. The constant varies with the type of population but for a mixed population of unadjusted male and female adults, is assumed to be one third.

It is possible to measure the vertical acceleration of the vessel using an accelerometer. It has been found from many trials that, broadly, an acceleration measurement at a single location can be used to predict the acceleration at any other place on the vessel by the use of a suitable linear scaling factor for that location. The factor will vary depending upon the location of the transducer, the location of the point of interest, and the vessel.

Using the raw accelerometer data it is practical to process it and display the resulting information to give an indication, within a minute or so of encountering a given sea state, of the propensity to vomit. This short time scale enables the captain to take preventative measures before his guests are feeling ill. It follows that, not only is there an adequate warning of the likely onset of sea sickness, but also the results of any preventative measures are readily available.

Following sea trials on several vessels and in discussion with the operators we developed an acceleration meter, on one vessel labelled and logged as 'Vommeter', that presents the information in a weighted acceleration form suitable for ascertaining the likelihood of sea sickness among passengers. Several variants are in use with the only difference being how the information is displayed. Displays include numerical, an arbitrary scale and coloured lights. Some operators take the information directly into their own systems for display and logging purposes.

Using the acceleration meter as a guide it is an easy matter to assess the risk of sea sickness, take the appropriate action, and see that it has been effective. The chances of getting it right by feel alone are not good since, although it is true that, provided the frequency remains the same, if the acceleration is halved the sea sickness will be halved, it is not easy to judge the frequency. BSI% is very frequency dependent as Figure 11 shows. It is apparent that people are most sensitive to motions with a period of 6 seconds and have little sensitivity to motions with periods less than one second.

### **Using the Most Comfortable Part of the Yacht**

As is well known by seamen, different parts of the vessel have different motion amplitudes under the same sea conditions, thus there are some parts on a given vessel that are more passenger friendly than others, broadly further towards the bow will be worst and low down near the centre line somewhere aft of midships will be best. In a typical yacht layout like the one in Figure 12 there are three prime regions of interest from the point of view of seasickness. These are:

1. Owner's Stateroom.
2. Guest Accommodation.
3. Lounge and Dining Area.

From model tests and associated computer calculations the propensity to vomit has been calculated according to the BSI% method, for a four hour voyage in various proposed sea states. The sea states were selected as not being too onerous and likely to be encountered when the owner and guests are on board with the vessel in the Mediterranean or Caribbean. In general for the same significant wave height the wave periods are longer in the Caribbean than the Mediterranean. Reproduced in Figure 13 are BSI% data for the owner's stateroom of a 60 metre vessel.

It can be seen from the data that the wave height has a significant effect on the results although the trends are the same irrespective of wave height. Thus a comparison of BSI% data for the three primary locations at one selected sea state will be representative of most sea states.

Figure 14 illustrates that in head and bow seas, for a given speed, the BSI% changes markedly with location. For example at 15 knots the propensity to vomit in a voyage of 4 hours is about 60% in the owner's stateroom, 40% in the guest accommodation and 30% in the aft lounge and dining area.

It follows that during the day time the owner should not languish in his state room when the weather gets rough but go aft to the lounge area where the motions are a factor of two less. Similarly, if practical, at night the owner would be well advised to occupy an aft guest cabin, sacrificing space and comfort in the interest of an easier night rather than a queasier night.

From Figure 14 it can also be seen that a reduction in speed and/or an alteration of heading will reduce the motion effects of the vessel, which is something the captain will take into account when deciding on the preventative measures mentioned earlier.

### **Monitoring to Ensure Structural Integrity**

For some time many commercial vessels have been fitted with structural monitoring systems. Primarily these systems are fitted to monitor two types of possible failure: failure due to global deflections and associated stresses; and failure due to local stresses. With the trend for larger and faster yachts there has been an increase in structural failures as a result of dynamic loading. Some yachts have failed due to an overall longitudinal weakness resulting in high local stresses, and others have failed locally due to excessive local loads. Both types of failure can be avoided with suitable monitoring equipment.

Monitoring equipment has been fitted to mega-yachts for one of two reasons, either to prevent failure or to monitor repairs made after a failure. In our experience, unfortunately for the owner, it tends to be fitted once the yacht has broken. Neglecting the acceleration meters mentioned previously, which are a limited form of structural monitoring, the Wolfson Unit has experience of just one instance where an owner had the foresight to specify monitoring equipment from the outset. In this example the vessel still suffered a structural failure because on that particular voyage the system had been ignored by a captain new to the vessel.

At the heart of any structural monitoring system is the software which acquires the data, conducts the analysis, and presents the results in a meaningful way. We have found that standard systems do not offer sufficient flexibility to enable the most to be gained from monitoring. Our approach is to adopt a system design developed for a previous vessel and adapt it to the requirements of the particular vessel concerned. By using engineers who are expert in software development, structures and ship operations, this proves to be cost effective.

A typical system will consist of transducers, signal conditioning amplifiers, a computer, and a link to the existing on board monitoring system. A schematic of a system developed for a large sailing vessel is shown in Figure 15. In this instance the system was self contained and data were not required to be available for the existing on board system.

Invariably, data from transducers are gathered as time histories by the computer, and are then analysed to yield statistical quantities which enable many incoming values to be presented, as a single value or a limited number of values. A typical sub-set of time histories is presented in Figure 16.

These data were gathered from a system installed to monitor overall bending of a vessel and subsequently to provide permanent fatigue records, and a forecast of failure, with reference to known 'hot spots' derived from a finite element analysis of the structure. The vessel had failed previously in regions of locally high stress brought about by modest longitudinal bending. The repairs included attention to detail in high stress regions and an increase in longitudinal strength. To date the repairs have proved effective. Since the data are available whilst the vessel is underway, the captain is able to take preventative action by altering course and/or speed to reduce the stresses on his vessel.

When monitoring systems are installed to provide information on local high stresses, for example slamming loads in the bow region, or very high pressure in the aft planing region of fast craft, it is important that these systems are capable of analysing the data in real time and giving the captain warning or alarm information as soon as possible. He can then take action immediately, to prevent damage, by reducing speed.

Figure 1

Variation of Roll Response With Bilge Keel Depth

Data Derived from Model Tests on a 41 Metre Motor Yacht

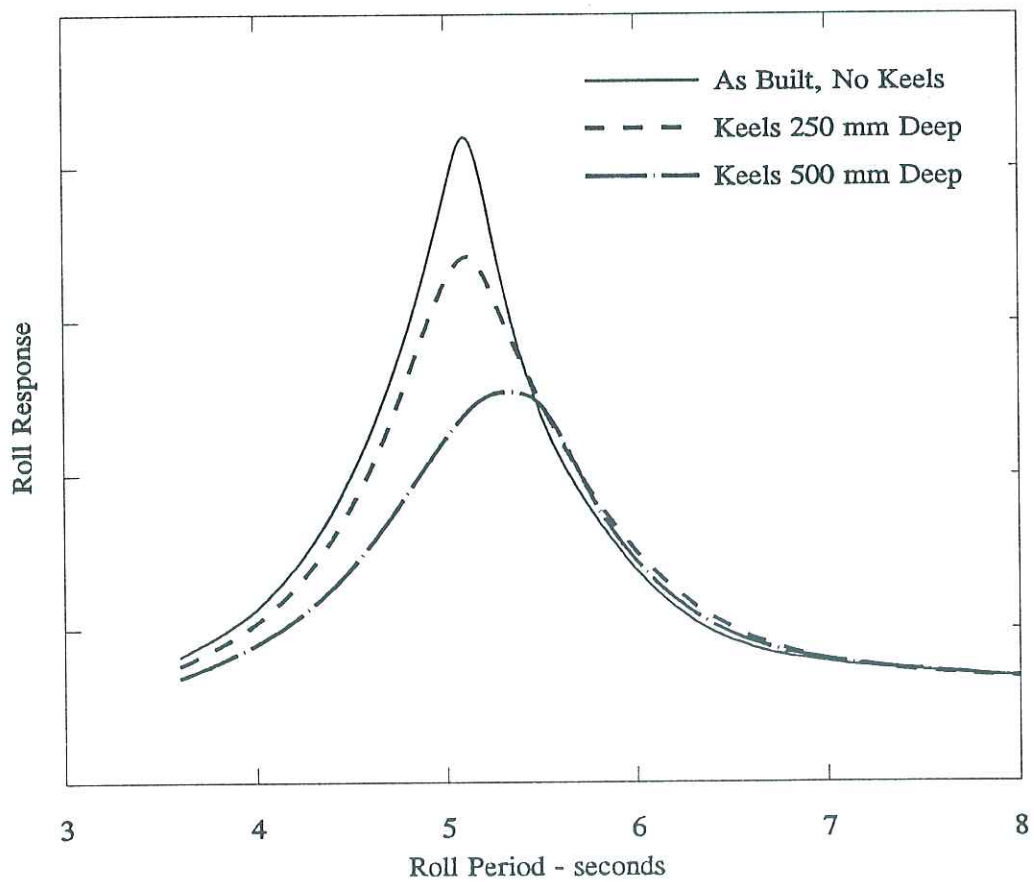

Figure 2

Variation of Roll Angle with Bilge Keel Configuration

Comparison of Unforced Roll Decay from Model Tests

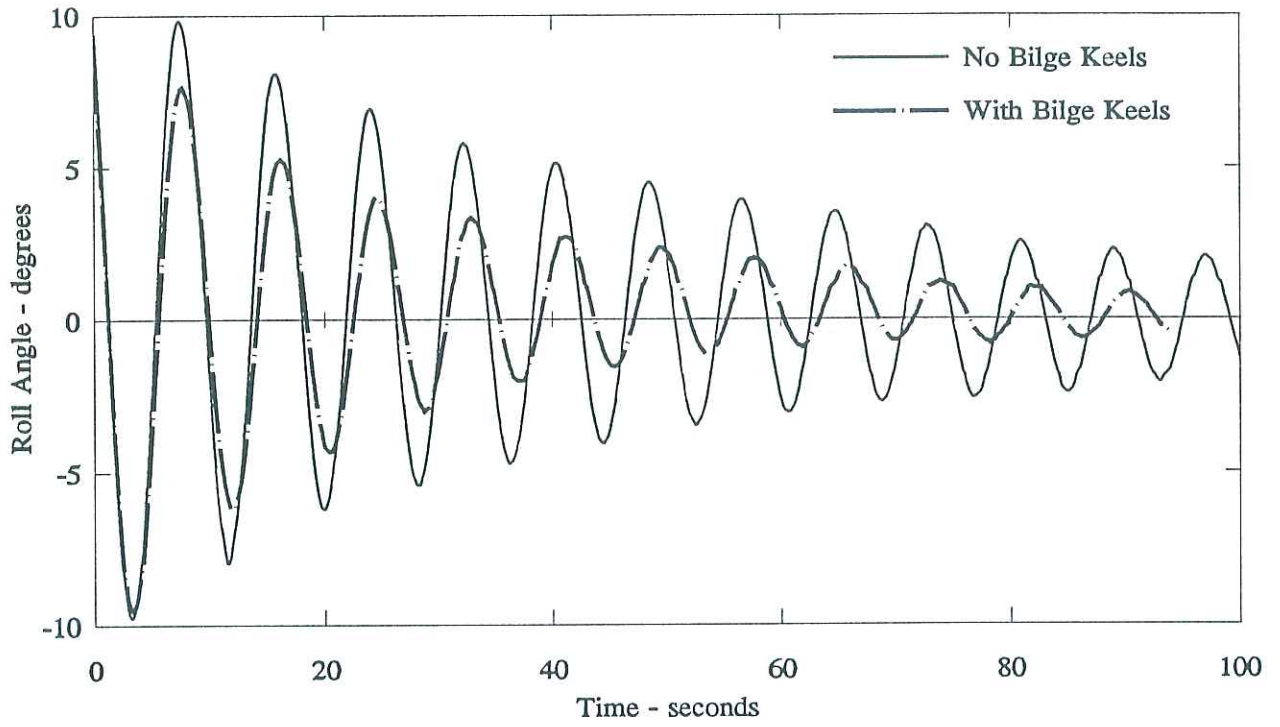



Figure 3

Variation of Roll Response With Bilge Keel Size

Data are For a 60 Metre Motor Yacht Beam On to the Waves in a Range of Seastates

Significant Wave Height and Period

- Waves 0.5m 4.5s
- - - Waves 1.0m 5.1s
- — — Waves 1.0m 7.0s
- Waves 2.0m 6.4s
- - - Waves 2.0m 7.7s

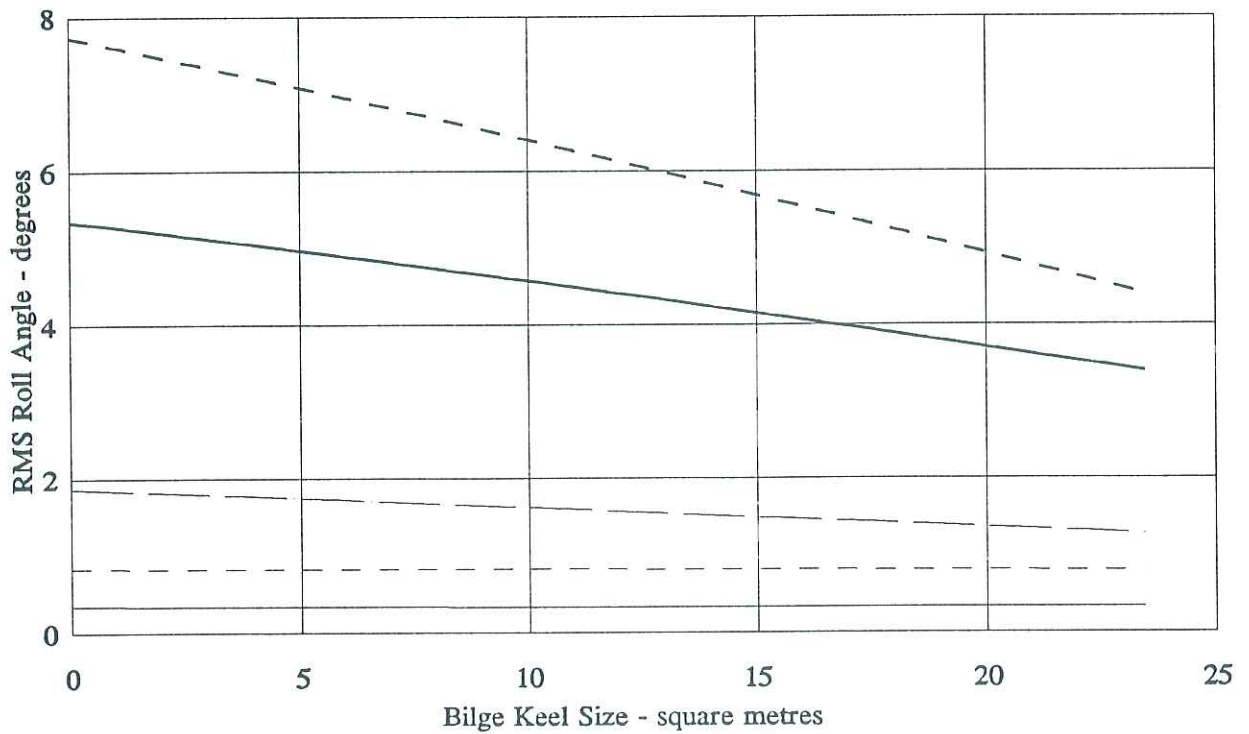

**Figure 4**

**Paint Flow Visualisation to Show the Pattern of Flow Around a Poorly Aligned Bilge Keel**

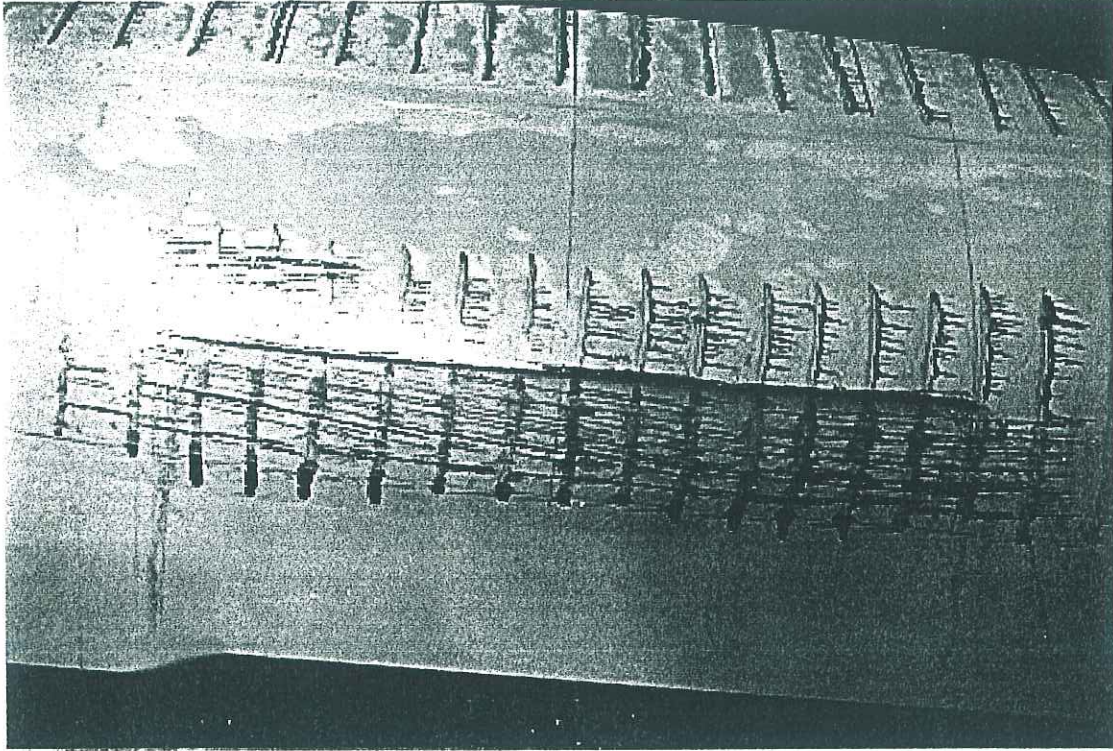

**Figure 5**

**Paint Flow Visualisation to Enable Alignment of New Keels**

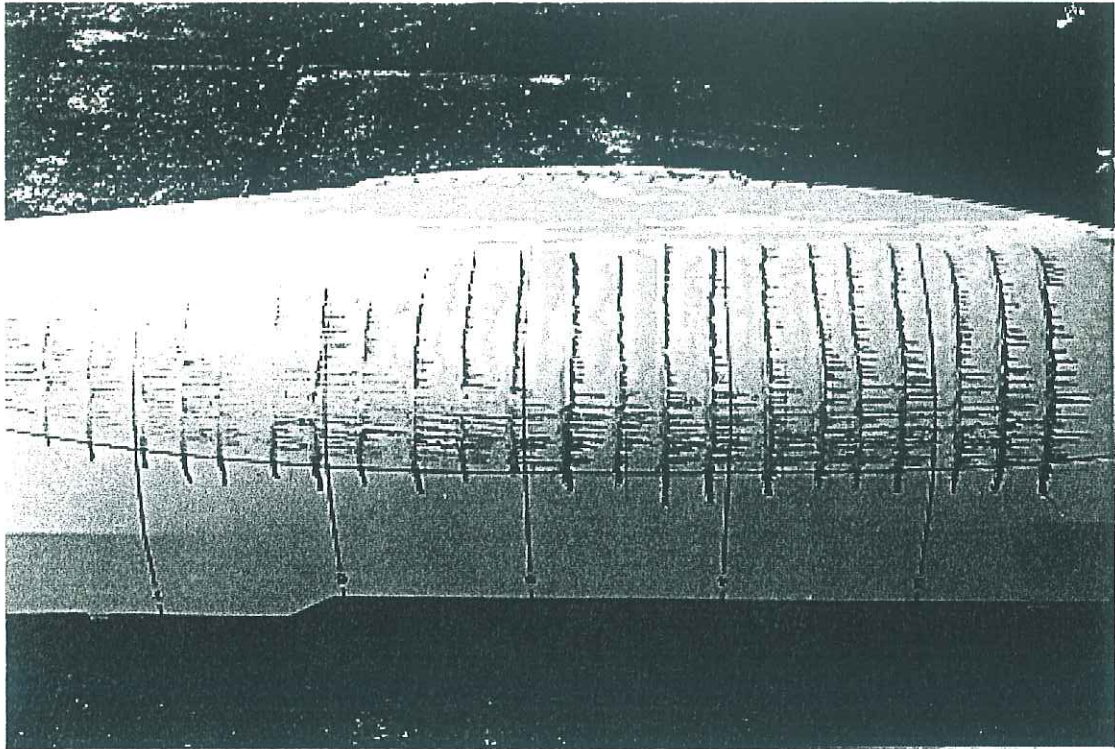

Figure 6  
Flow Lines and Alignment of Bilge Keels  
Data for a 64 Metre Coastal Survey Vessel

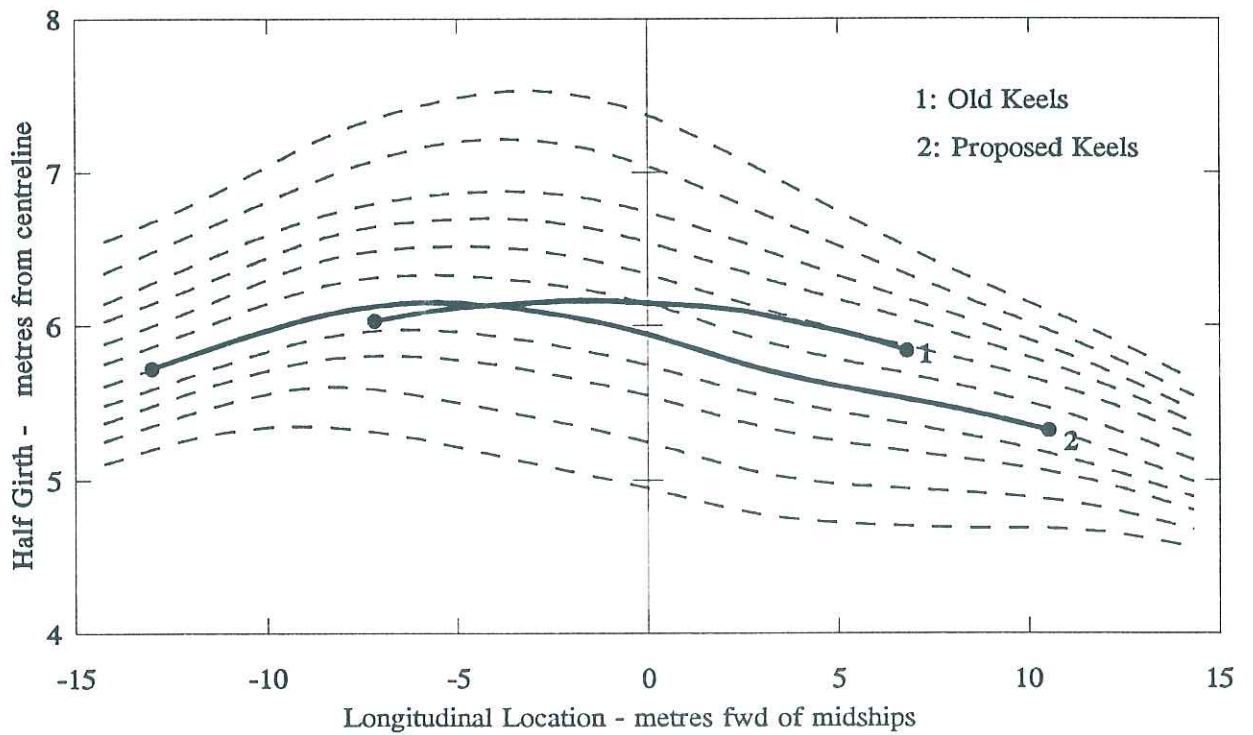
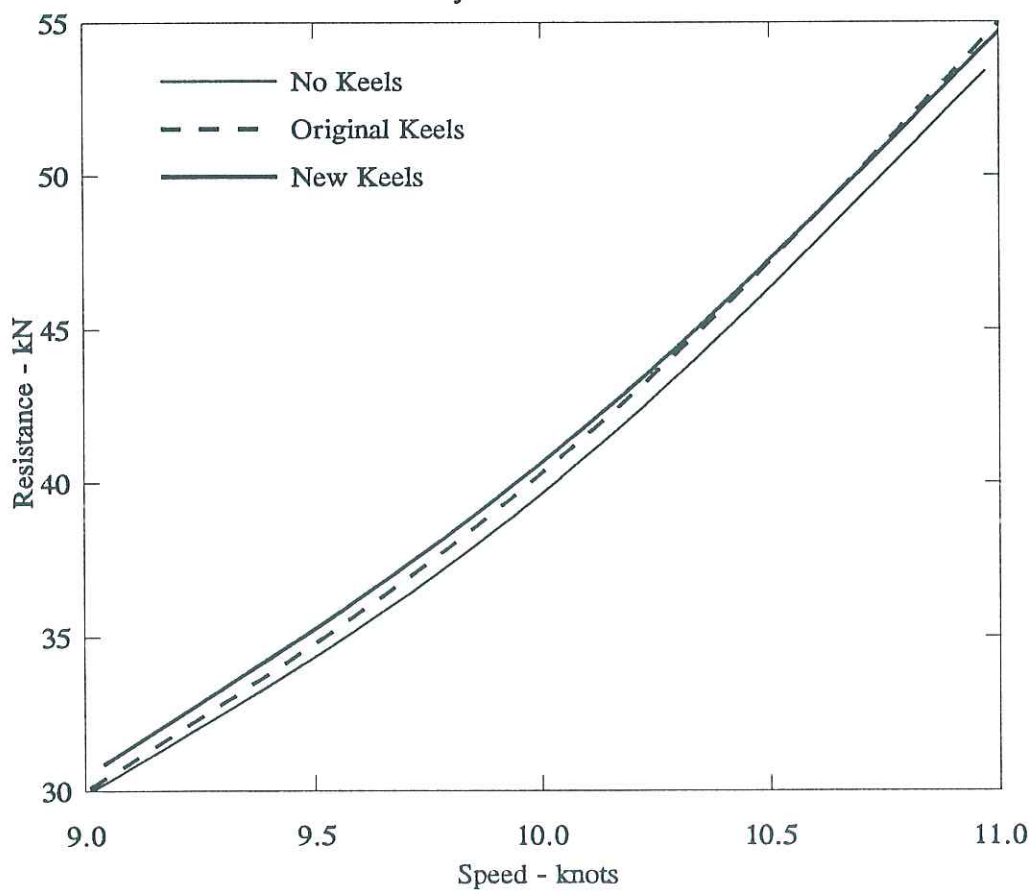

Figure 7

The Effect of Bilge Keels on Resistance

Data for a 64 m Coastal Survey Vessel



**Figure 8**

**A Motor Yacht Model Prepared for Towing Tank Tests, with Large Keels  
Correctly Aligned**

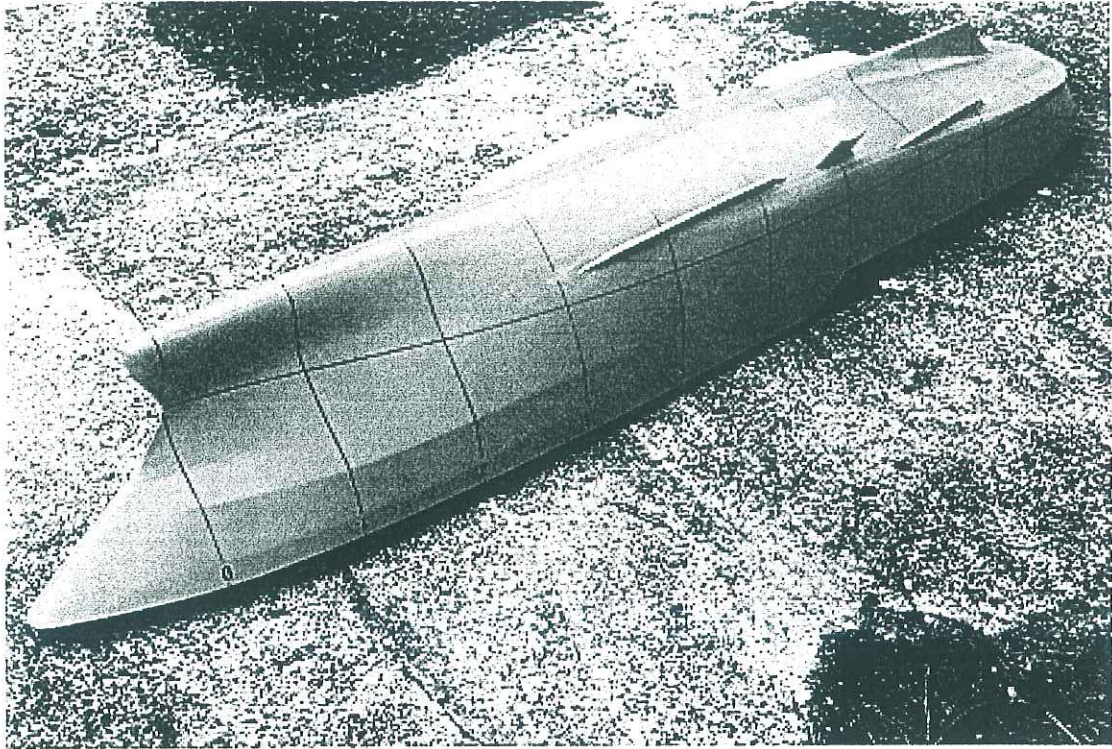

Figure 9

A 1:18 Scale Model of a 40 Metre Motor Yacht Undergoing Tests at 17 Knots in Waves of 1 Metre Significant Height

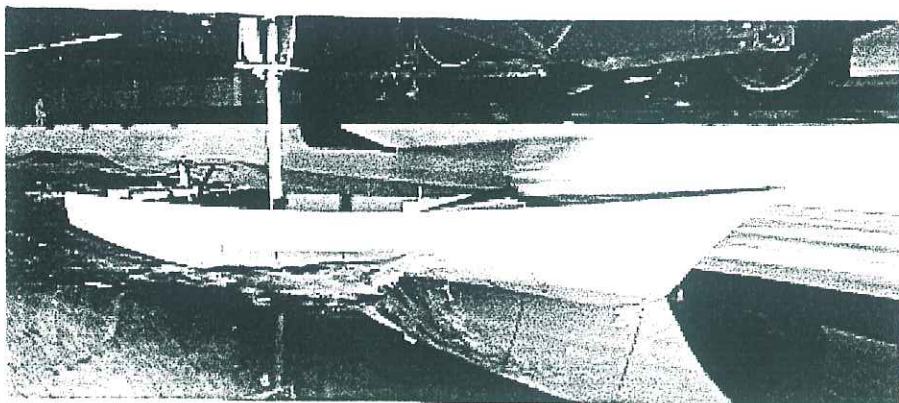
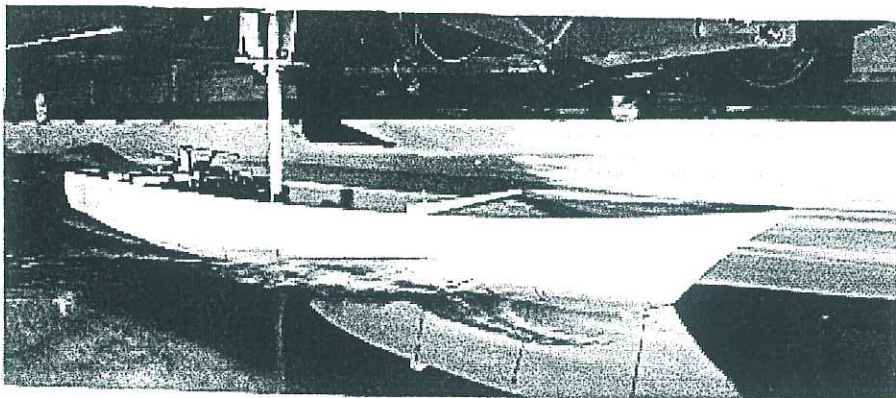
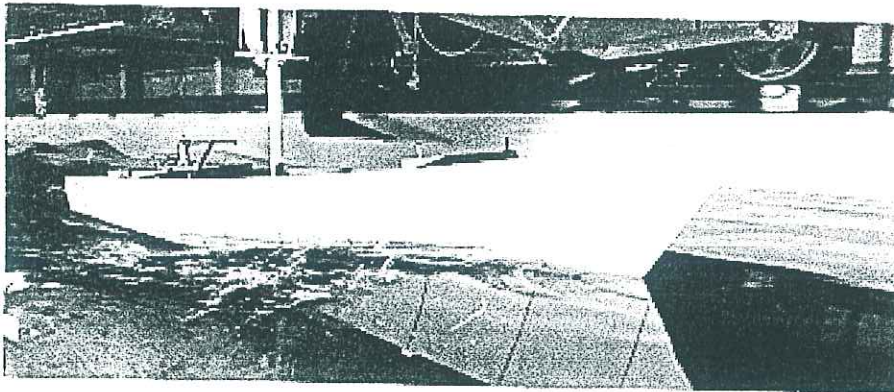
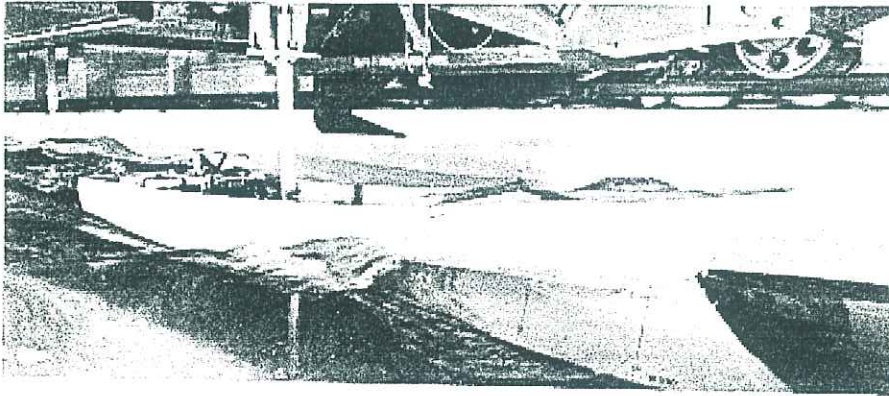

Figure 10

Equivalent Tests With a Spray Rail Fitted to Reduce Wetness

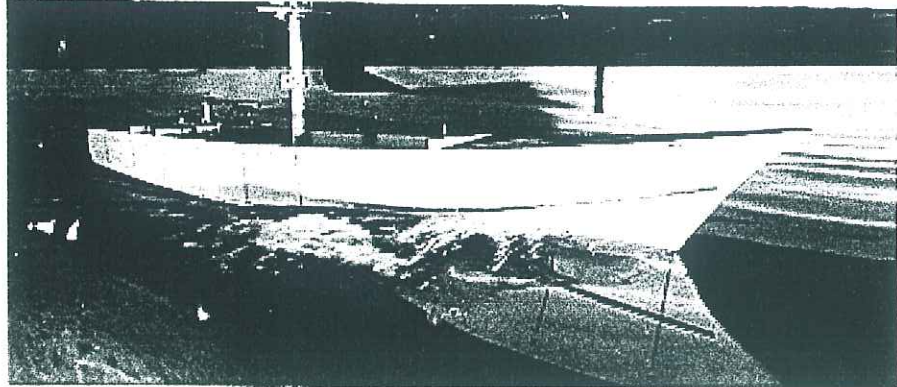
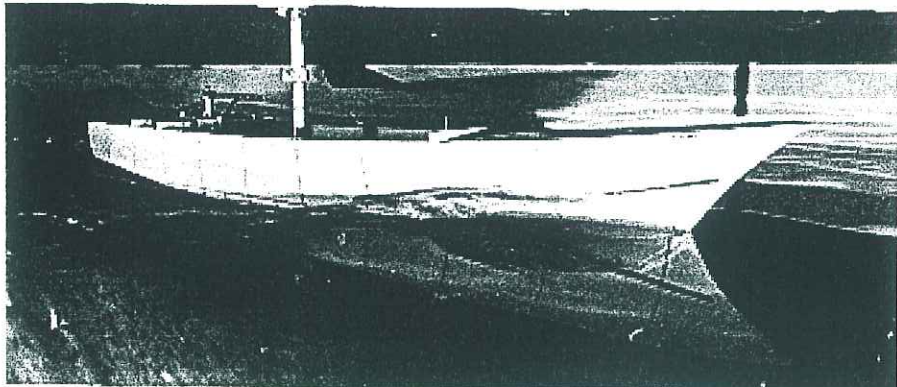
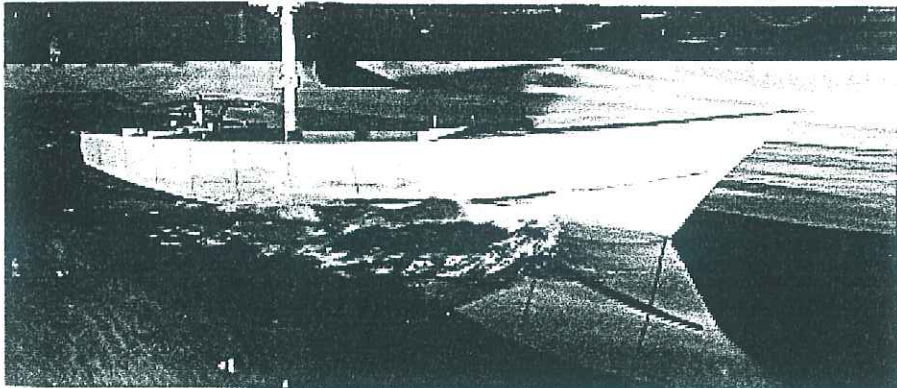
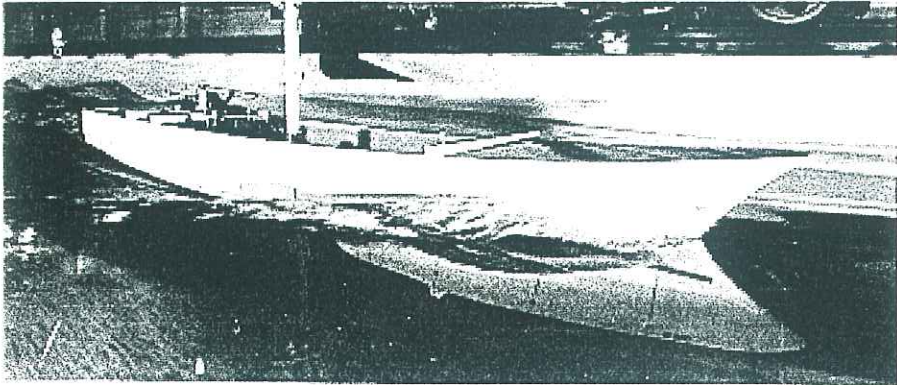
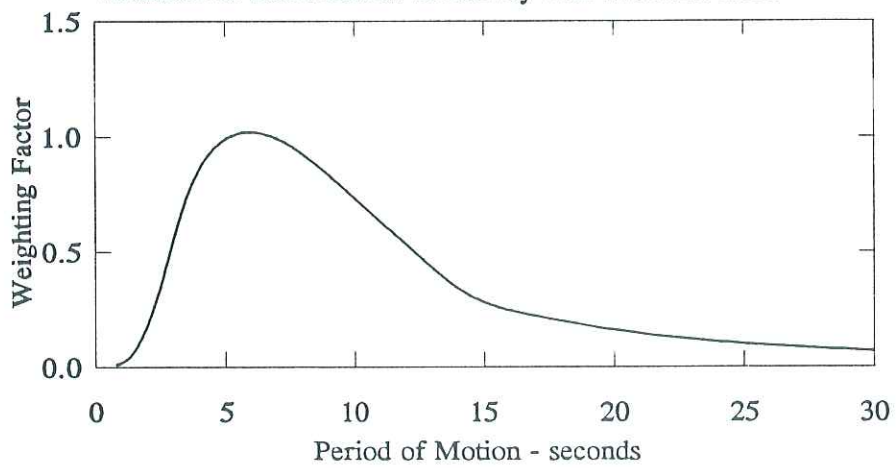



Figure 11

Variation of Sea Sickness Sensitivity with Motion Period



**Figure 12**  
**A Typical Large Motor Yacht Arrangement**

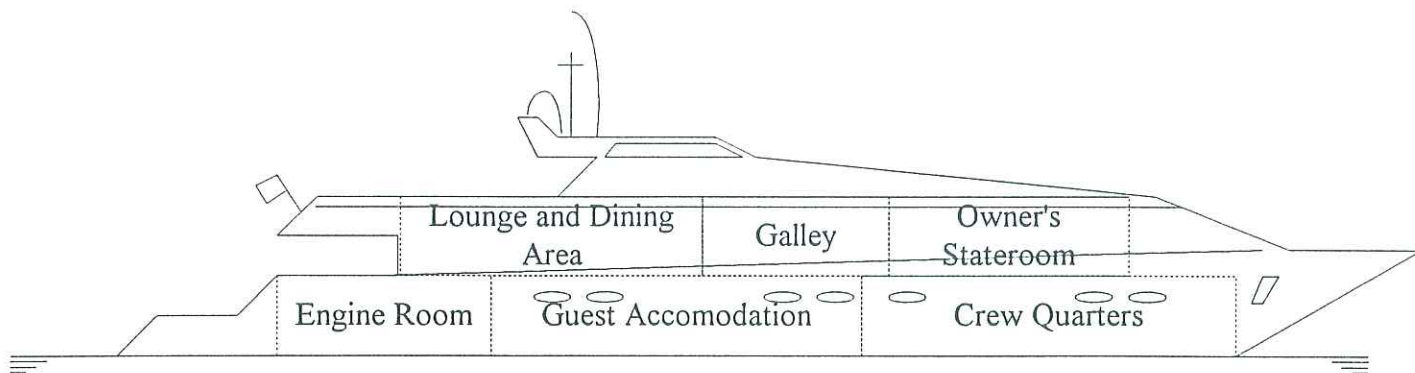

Figure 13

Variation of Sea Sickness in the Owner's Stateroom on a 4 Hour Voyage

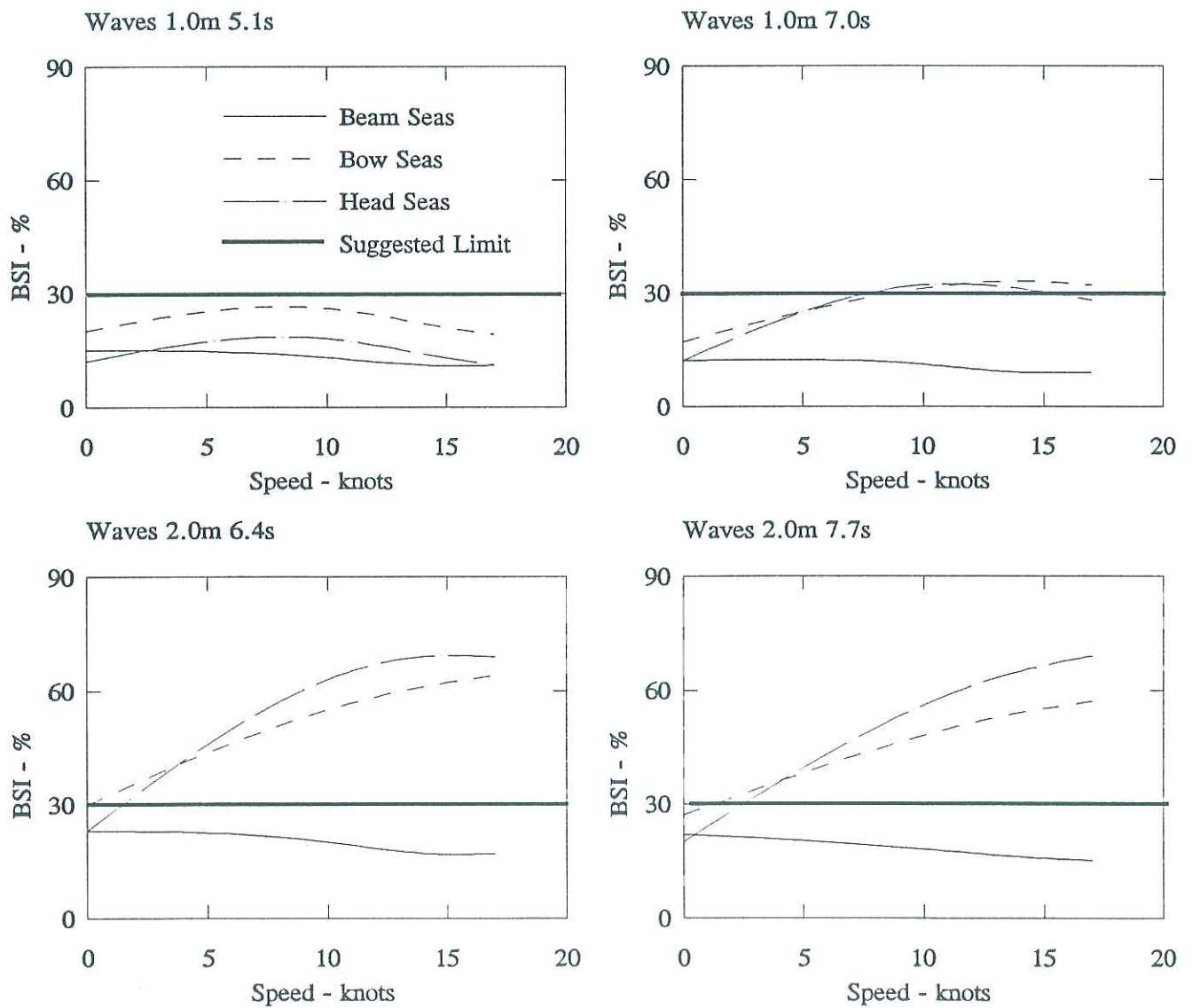
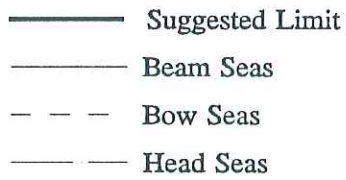

Figure 14

Variation of Sea Sickness in Different Locations on a 4 Hour Voyage

Waves 2.0m 7.7s



Dining Saloon

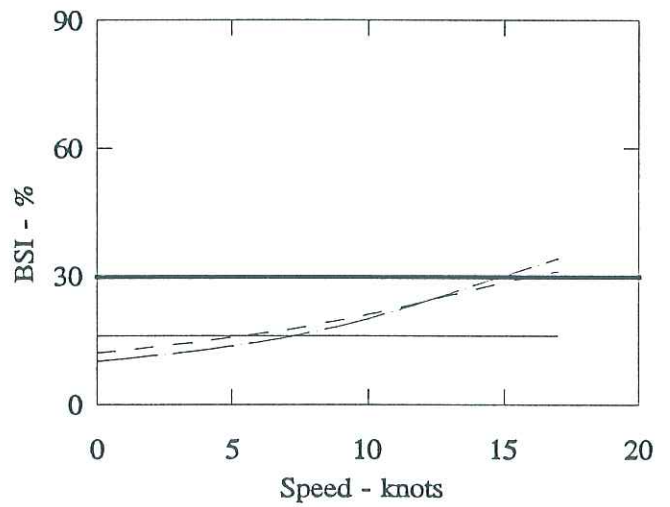

Guest Accommodation

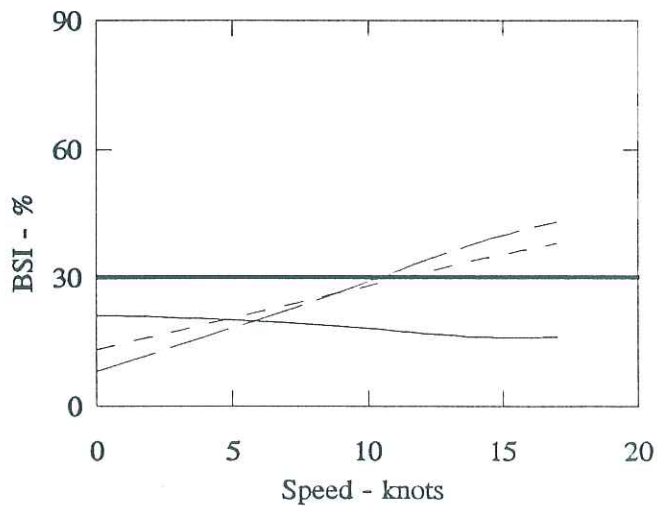

Owner's Stateroom

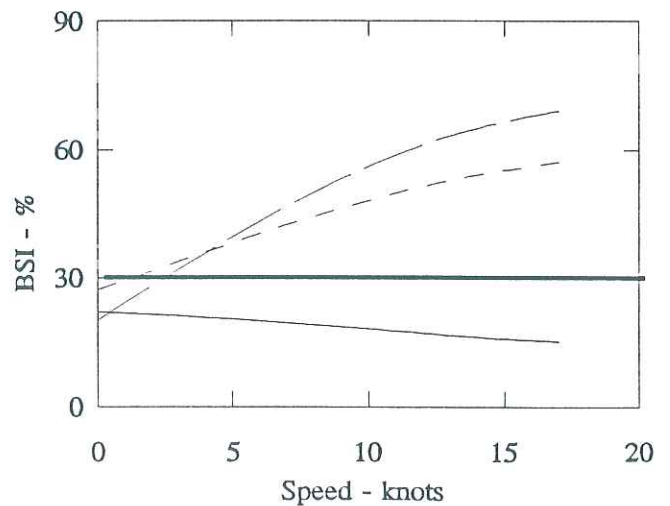

Figure 15

A System for Monitoring Rig Loads and Mast Strains on a Large Sailing Yacht

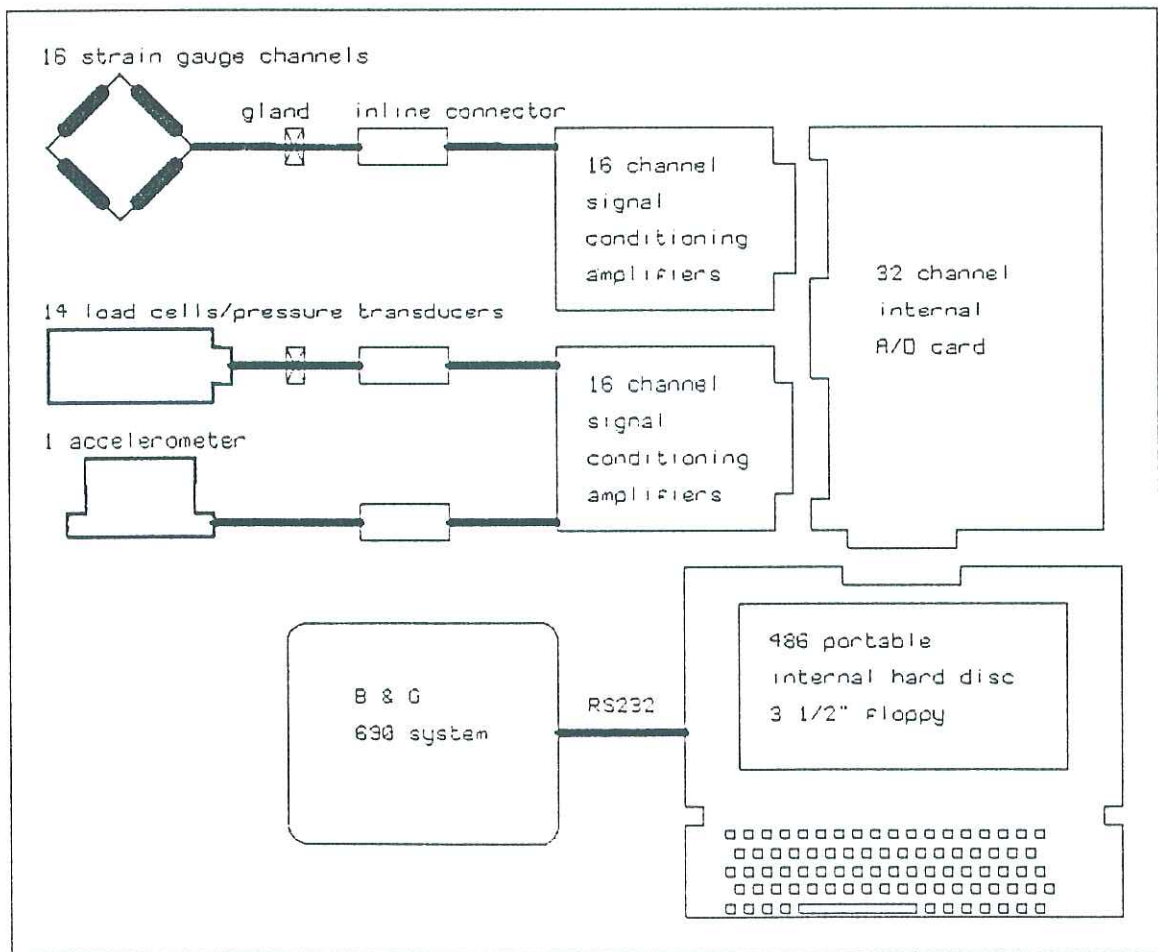
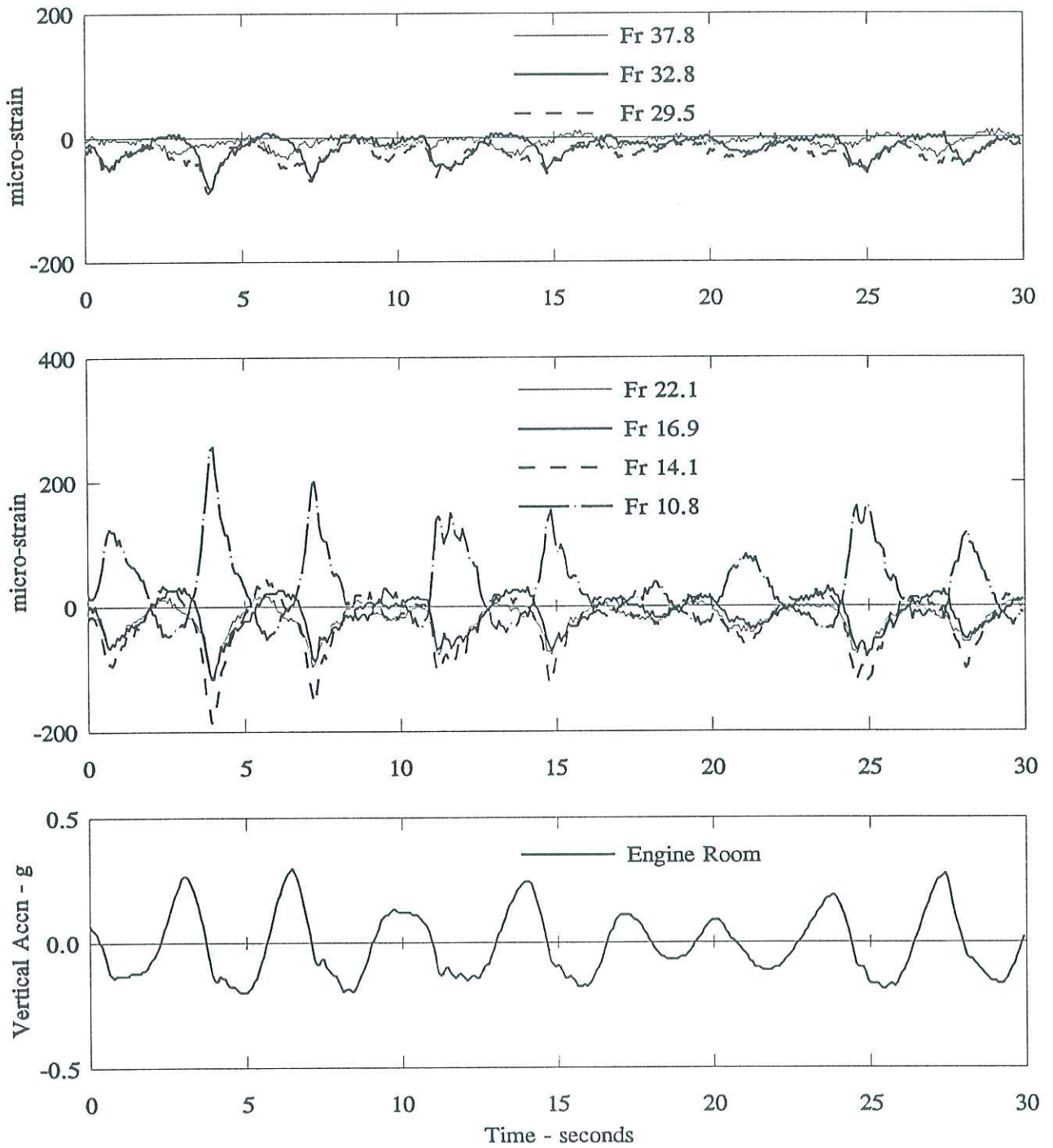

Figure 16

Structural Monitoring Time Series Data from a 56 Metre Motor Yacht

Sea State 4, Speed 15.5 kts



# QUESTIONS AND ANSWERS

## Chairman

Thank you very much. A layman like me could follow nearly all of that and I stayed awake too. Questions from the floor on that.

## Don Tracey - 'Splash' Marine

On the length of the bilge keels is it any relation to the water line length?

## Barry Deakin

The length of the keels is limited because if you take them too far forward they will come out in head seas. They will emerge from the water in head seas and then they will slam back in. So they should not be too far forward and if you take them too far aft it is difficult to bring them a long way aft because they may start to interfere with the flow to the propellers.

## Don Tracey

My question is, on a project I am doing right now we've got stabilisers and they have been taken out a long way aft of the stabiliser. They do not start for a long way past the stabilisers. Probably 4 metres and I just wondered why that was.

## Barry Deakin

Well, there is always a fear that the bilge keels and the stabilisers will interfere with each other and so it is always safer to leave a big gap. But I do not know that there is very much hard information on the actual effect of the interaction between them. So, stabiliser manufacturers will recommend that the keels do not extend closer than maybe two cords, forward and aft of the stabilisers. They have their own rules of thumb. But I think that is the best we can do at the moment.

## Chairman

Aren't there any captains or owners reps who have got experience of this. Yes, question there please.

## Reint Dallinga - MARIN

About those fin stabiliser interferences. I can confirm from model tests and measuring forces on bilge keels that in some cases you can lose considerable effect from your fins on your bilge keels so it is good practice to keep them separated to some extent.

## Chairman

Just to repeat my question. Are there any captains or owners' reps. Yes...It is always useful to get practical experience of these things.

## Tork Buckley - Jade Marine

We have bilge keels that do not work. They are too small. I think. And aligned for the convenience of attachment.

## Barry Deakin

They were aligned along a diagonal formerly when the ship was built they just straight line along the bilge.

## Tork Buckley

But they do not work.

## Barry Deakin

No. Not big enough. Well, you can see from the diagrams that they do need to be big to work effectively.

## Chairman

Thank you very much. That is an interesting practical example. Any further questions from the floor.

## Barry Deakin

One of the examples that I showed there was a 47 metre mine sweeper operated by the British Navy and that was notorious for rolling excessively and they recorded rolls in sea state five of 70 degrees. Total 70 degrees. That is total port to starboard and they had a man out on trials to measure these and he was not used to the ship and only just survived the trials I think. But they fitted the large bilge keels and they also modified a passive stabiliser tank at the same time and the roll motions were reduced. They went out on trials in sea state 8 and only measured 20 degrees of roll. So the model results are born out full scale. There is plenty of information and plenty of satisfied owners that are amazed at the transformation of their yachts.

## Chairman

I can support Barry on the former. I have actually been on board a British mine sweeper rolling 35 degrees either way. It is some experience I will tell you. I was the only one on board, in fact, who was not sick by the end. Any further questions from the floor?

Well Barry all that remains is to thank you very much indeed. That was a fascinating paper.